

Recommendation of circuit connection to Hitachi high power 2in1 IGBT

In this application note, Hitachi's recommendation of circuit connection for Hitachi high power 2in1 modules is shown. Contents are as follows.

1. Recommended bus bar connection to realize low inductance.
2. Recommended gate circuit connection
3. Recommended bus bar support to avoid vibration damage.

Applicable product types are listed in Table.1.

Type name	V _{ces}	I _c
MBM600E17D	1700V	600A
MBM1200E17D	1700V	1200A
MBM800E17F	1700V	800A
MBM1200E17F	1700V	1200A
MBM400E25E	2500V	400A
MBM500E33E2	3300V	500A
MBM500E33E2-R	3300V	500A

1.1 Recommended bus bar connection to realize low inductance.

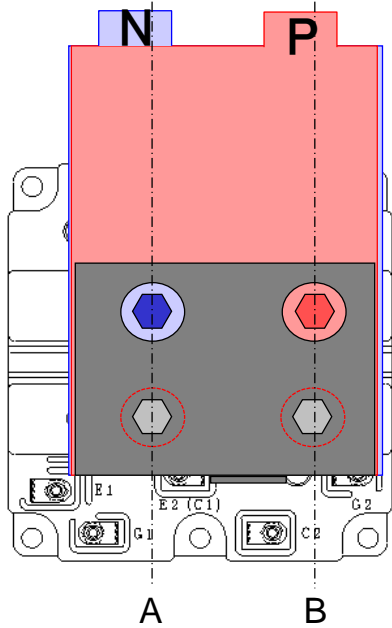

Fig. 1 Recommended bus bar

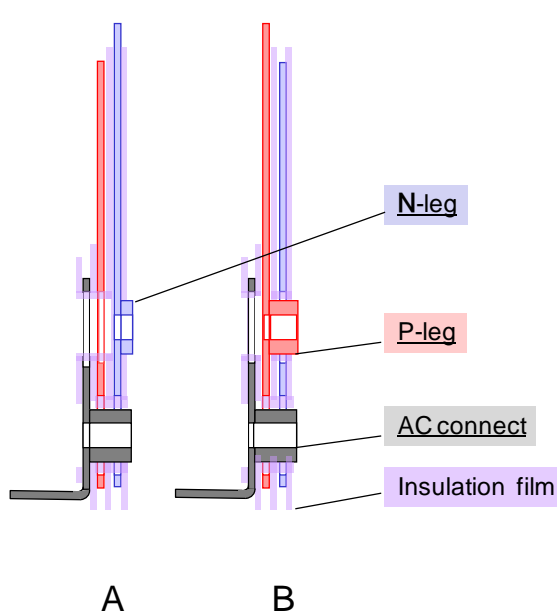

Fig. 2 Recommended bus bar, N-leg.

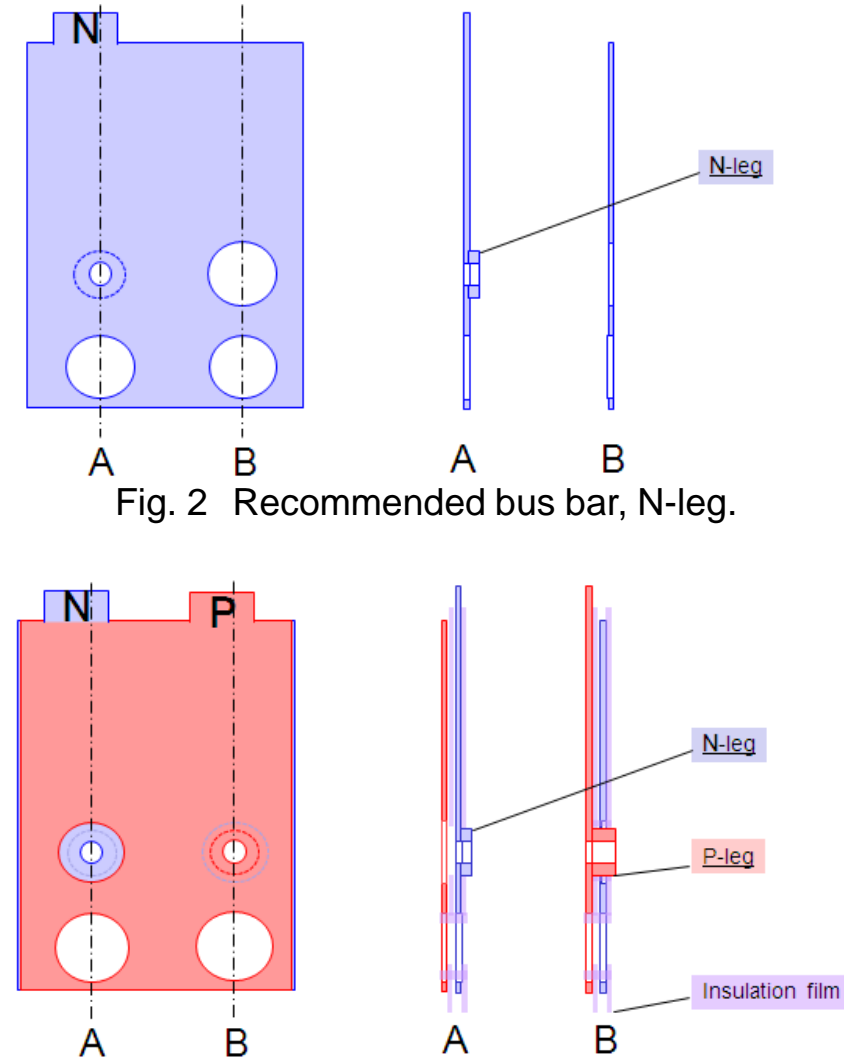

Fig. 3 Recommended bus bar, added P-leg.

Hitachi recommend a wiring such as Fig.1-3 to realize low inductance. Feature is that P, N and AC layer structure are piled up with insulation film between them. It can reduce the current loop. This external current loop might cause the imbalance of switching waveforms between upper and lower circuit. ***In this case, the current of external wiring does not influence on inside of the module, and low inductance circuit can be realized.***

1.2 Recommended bus bar connection to realize low inductance.

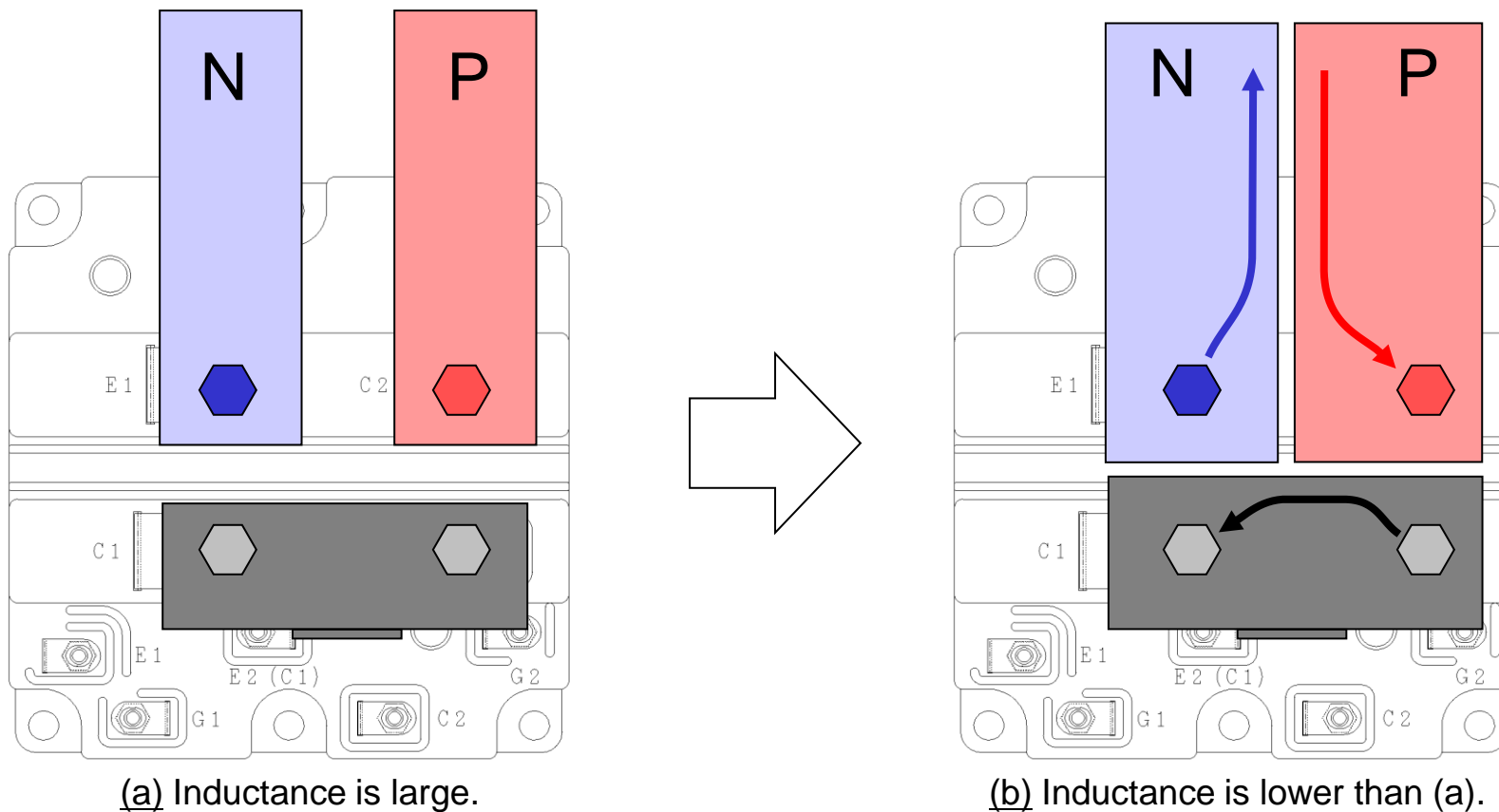
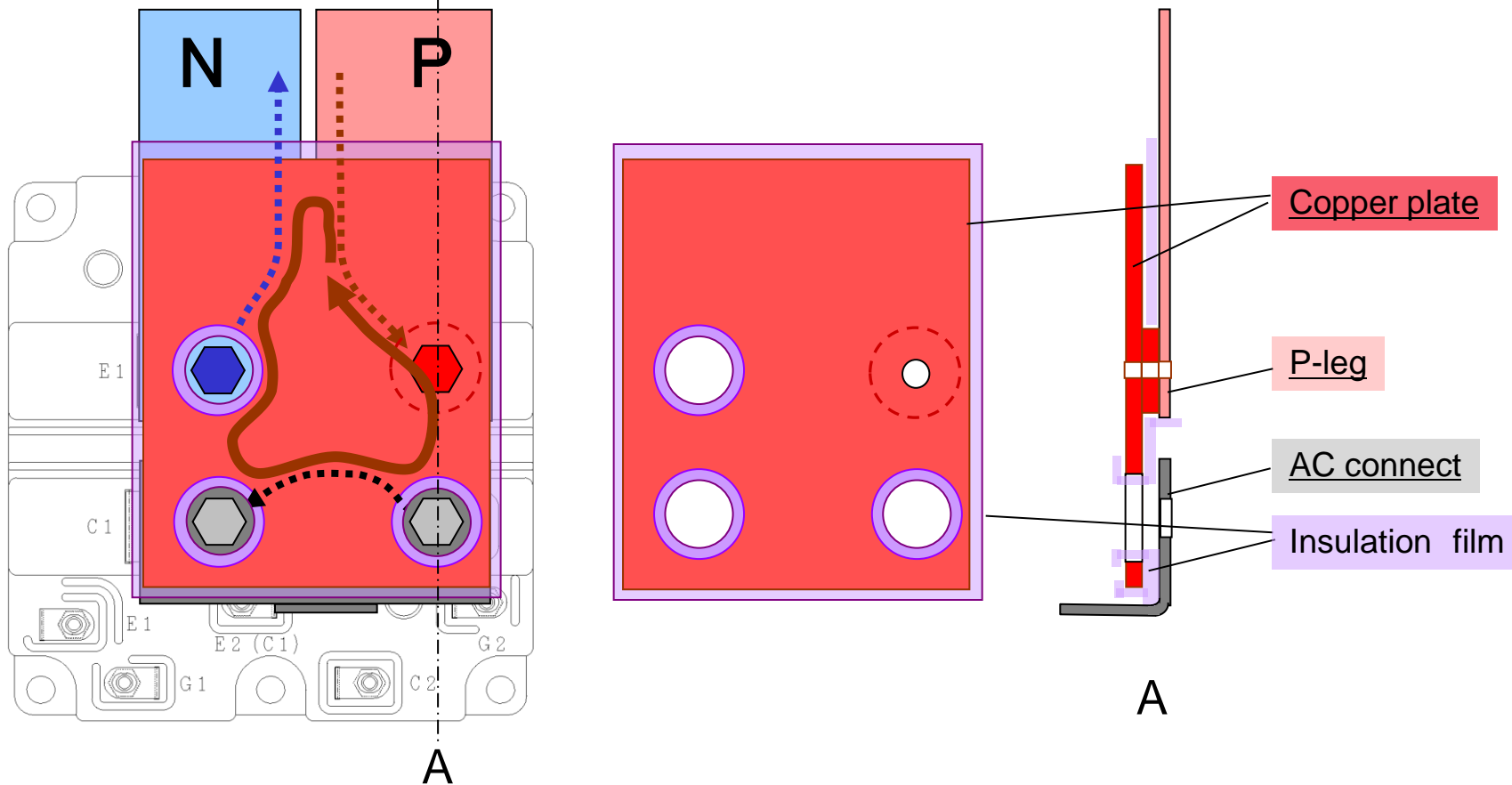

Fig. 4 Example of bus bar connection to realize low inductance.

Fig. 4(a) is not recommended, but it can be improved by closing each wirings. It is necessary to insulate with an insulating sheet between each wiring .

1.3 Recommended bus bar connection to realize low inductance.



(a) The eddy current in the copper plate.

(b) Recommended copper plate.

Fig. 5 Recommended bus bar connection to realize low inductance

For further improvement, adding copper plate onto the bus bar is recommended.

In this case, the influence of current loop of $N \Rightarrow AC \Rightarrow P$ is cancelled by the eddy current ($N \Rightarrow AC \Rightarrow P$) in the copper plate.

2 Recommended gate circuit connection

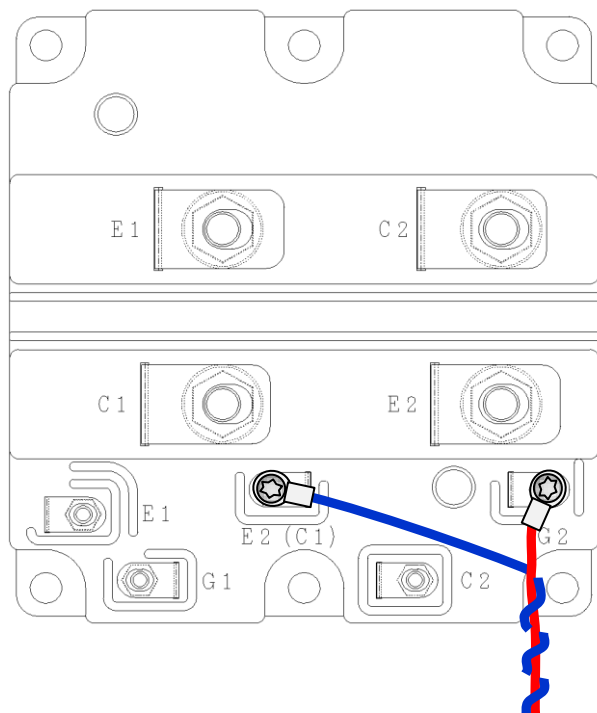

Fig. 6 The loop between gate-emitter is large.

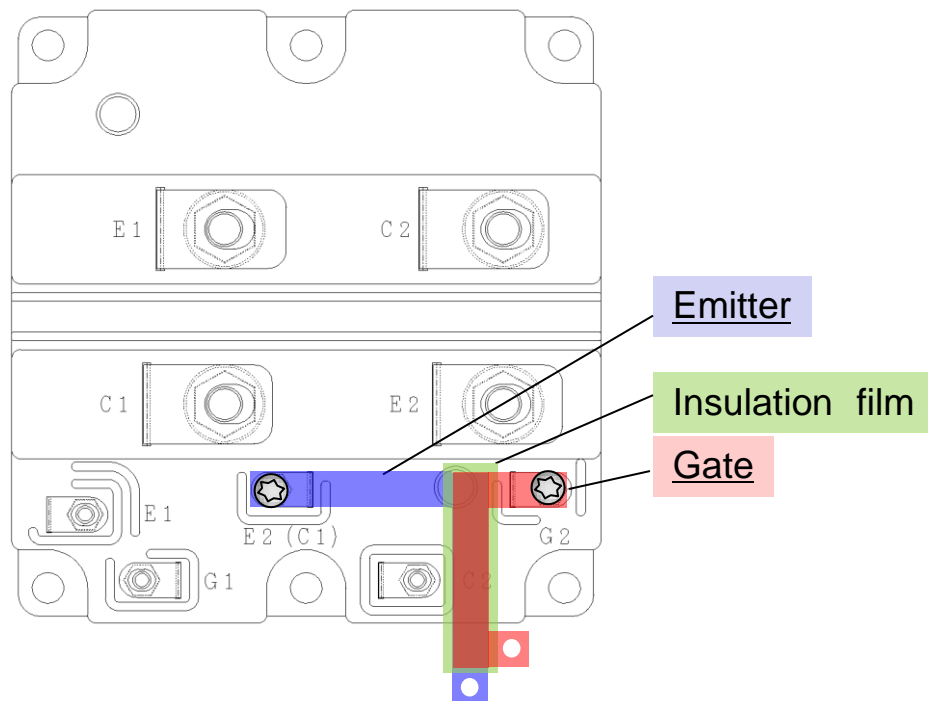

Fig. 7 The loop between gate-emitter is small.

Recommended gate circuit connection is shown in Fig. 7. It is necessary that the design of gate wiring be shortest. In the case of Fig. 6, the loop of gate wiring is large. Thus, there is negative influence on the gate signals when large current flows in the main circuit.

In the case of Fig. 7, gate and emitter wirings are copper plates, and insulation film is inserted between gate and emitter wiring. This structure would be the shortest gate wiring.

3 Recommended bus bar support to avoid vibration damage.

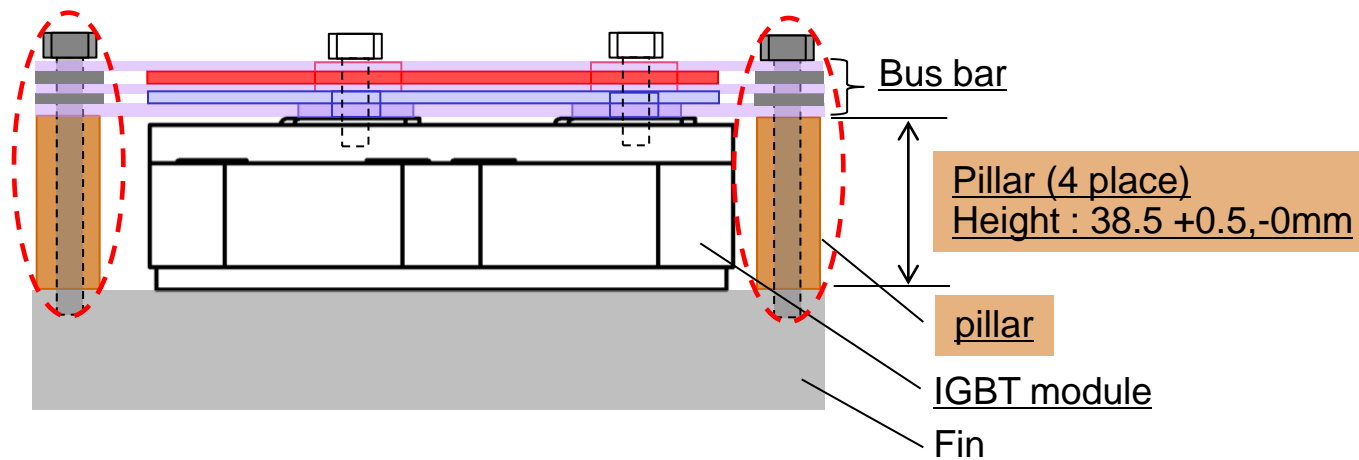

Fig. 8 Supported by isolation pillar.

It is necessary that the weight of the bus bar is not loaded to the main terminals of IGBT modules. To avoid vibration damage, the bus bar should be supported by isolation pillar.

HITACHI
Inspire the Next